

# ASSEMBLY

## IMPORTANT ASSEMBLY INFORMATION

- Assembly requires a Phillips Head screw driver is needed to assemble trampoline/enclosure. However, screw driver are not provided. During the installation of springs, wear gloves and protective eye wear.
- Assembly requires two persons. Keep children away from the trampoline/enclosure until it is fully assembled.
- Use gloves to protect your hands from pinch points during assembly.
- The assembly steps refer to parts by their descriptions and key numbers (see the PART LIST on page 22). If a part is missing, see ORDERING REPLACEMENT PARTS on page 23, 24.

## TRAMPOLINE/ENCLOSURE PLACEMENT

1. Place the trampoline/enclosure on a level surface before use.
2. Adequate overhead clearance is essential. A minimum of 7.3 m (24 ft.) from ground level is

recommended. Provide clearance for wires, tree limbs, and other possible hazards. Lateral clearance is also essential. Place the trampoline away from walls, structures, fences, and other play areas. Maintain a clear space on all sides of the trampoline/enclosure.

3. Use the trampoline/enclosure in a well-lighted area. Artificial illumination may be required for indoor or shady areas.
4. Secure the trampoline/enclosure against unauthorized and unsupervised use.
5. Remove any obstructions from beneath the trampoline/enclosure.
6. The owner and supervisors of the trampoline are responsible to make all users aware of practices specified in this manual.
7. The trampoline/enclosure is only to be used as an enclosure for a trampoline.

1. Separate all the parts by markings as shown:  
Qty 6 - Key #1 top rails A/B with T-connector  
Qty 6 - Key #2 top rails A/B with POD-connector  
Qty 12 - Key #3 Leg extensions  
Qty 6 - Key #4 'W' shaped legs

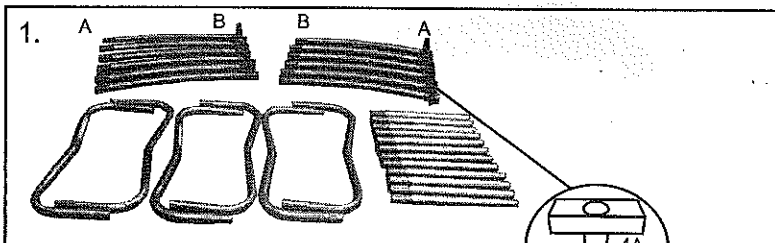

- 1.1 Start assembling the 6 sections by:  
Connecting top rail Key #1 to top rail Key #2.

Once complete, there will be a total of 6 sections as shown in the diagram.

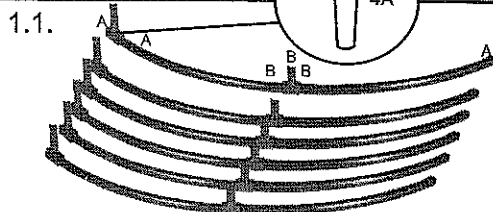

- 1.2 Once you have all 6 top rail sections assembled and laid out in rows:  
Start by connecting the leg extension into the T-connector & POD-connector.

Finish by connecting the 'W' shape leg into the leg extensions. Repeat the steps above for the remaining sections. Please note: You must alternate the legs as shown in the diagram or the frame system will not be assembled correctly.

2. Once you have all 6 sections completed:  
Please note: There are 6 different sections of legs.  
Start laying the sections out.  
Make sure that 6 like leg sections lay across from each other.  
Repeat with remaining leg sections as shown in the diagram.

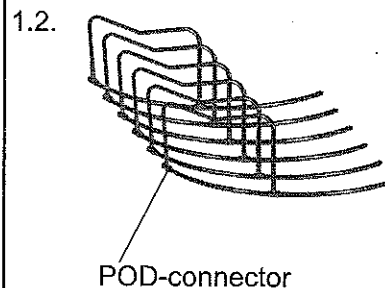

- 2.1 Have 2 people begin connecting the 6 sections together.
- 2.2 Once the sections are connected, the frame will form a full circle.

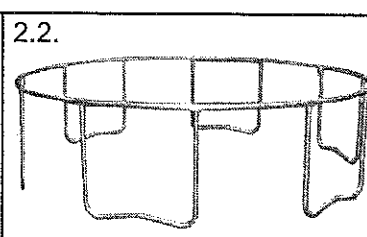
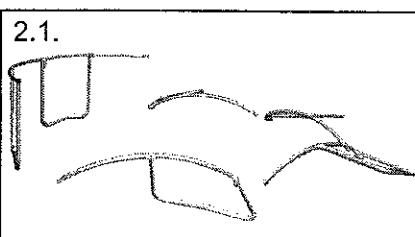
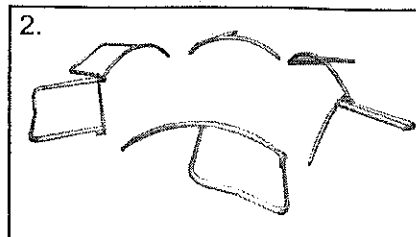

3. Lay the Bed (7) on the ground inside of the assembled frame. Make sure that the two warning decals (not shown) are on top of the Bed.

Note: There are V-rings around the edge of the Bed (7) and holes around the top of the frame. During this step, you will attach the Bed to the frame using the included Springs (9) for holes on top of frame and for holes on bottom of frame (see the inset drawing). Hook a spring to the Bed(7) and using the spring pulling tool(18), pull the spring from the Bed to the hole slot in the trampoline frame with even spring tension. Be careful where you place your hands, the Springs and frame joints can pinch.

To attach each Spring, you will first hook one end of the Spring into a V-ring with colored webbing location (see the inset drawing).

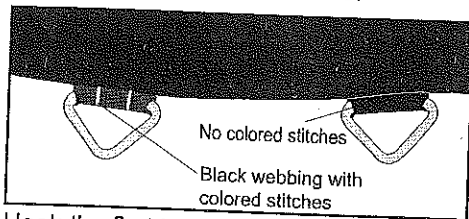

Hook the first two Springs(9) into the two V-rings on the jumping surface(7) and into the holes on the Top tube. Attach two more Springs(9) to the black webbing with colored stitches. Go to the opposite side of the jumping surface and attach 2 more springs (9) to the black webbing with colored stitches.

Attach two more Springs(9) with color stitched webbing location halfway between the first/second Spring(9), so eight Springs(9) are attached as shown. Attach four more Springs(9) (not shown) halfway between the first eight Springs(9). Continue attaching Springs(9) halfway between the previously attached Springs, until all the Springs are attached.

**During the installation of springs, wear gloves and protective eye wear.**

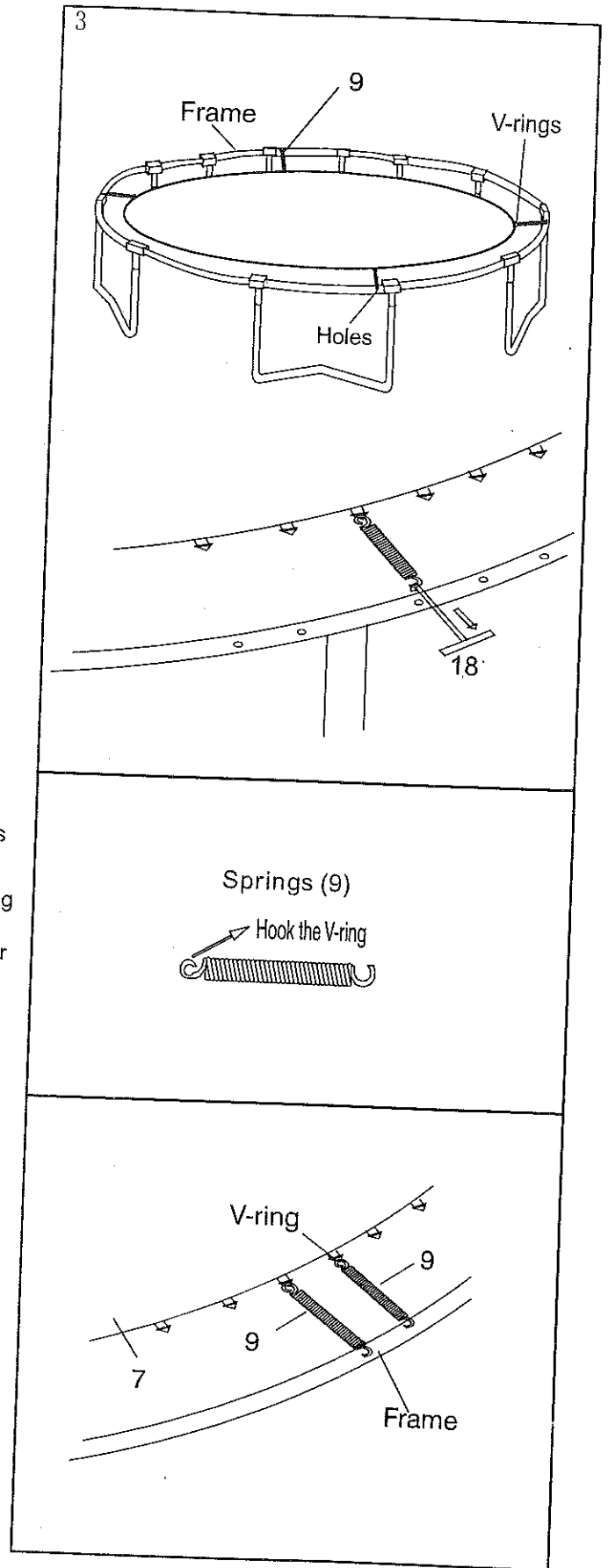

4. Lay the Frame Pad (8) on the frame.

**Do not use the trampoline without the Frame Pad (8),** which is designed to reduce the likelihood of injury to the user from coming in contact with the trampoline frame. If you do not have a Frame Pad, call our Customer Hot Line toll-free at 877-927-8777, Monday-Friday, 8 a.m. -5 p.m. Central Time. (Excluding Holidays) Properly install the Frame Pad before using the trampoline.

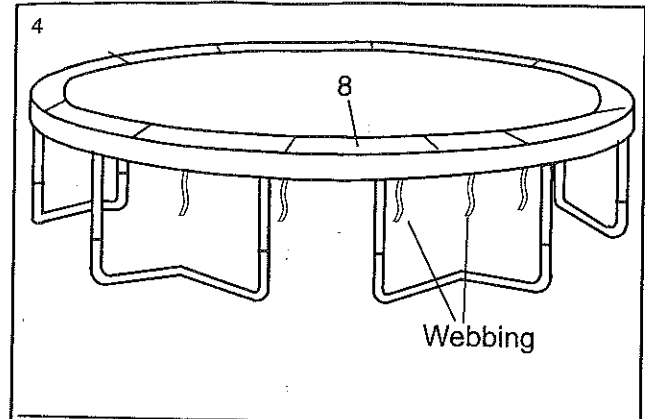

5. Look under the trampoline and locate the pairs of straps near the edge of bed(7) and Double D-ring and webbing near the frame.

See the inset drawing. A, B and C. Repeat this step with the remaining straps (not shown).

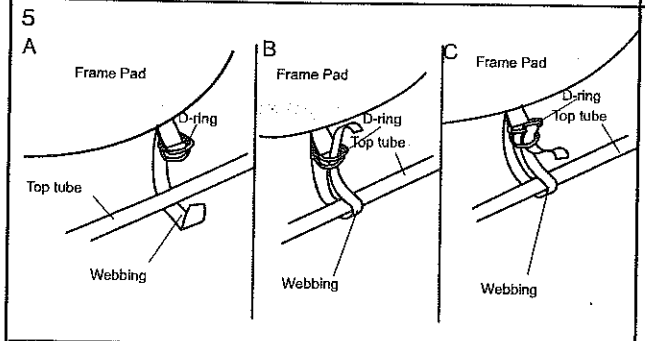

Thread one end of Elastic Tie-Down, then tie a knot on V-Ring.

Repeat this step with the remaining straps which at middle position of each pad section (not shown).

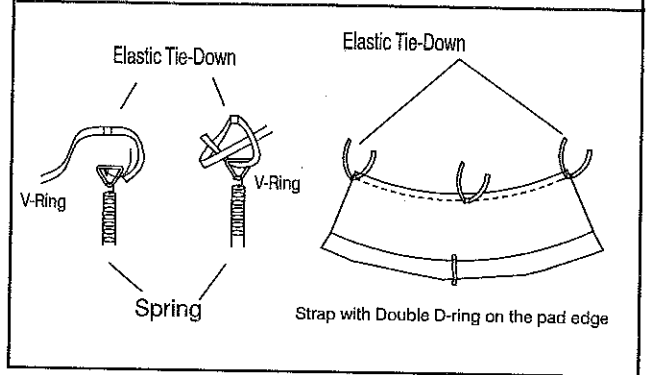

- The trampoline is now fully assembled. Make sure that all parts are securely attached. Familiarize yourself and all users of the trampoline with the safety precautions, use and instructional materials, and care and maintenance instructions in this manual before using the trampoline.

- Lay a Straight Tube (12) and a Top Tube (13) with Plastic Cap on the ground.

Make sure that the Straight Tube (12) is oriented so the small holes are in the position shown. Slide a Foam Sleeve (16) onto each of the tubes; note that the ends of the Straight Tube (12) should not be covered.

Insert the Straight Tube (12) into the Top tube (13). Tighten a Self-tapping Screw (11) into the small hole in the Tube (12,13).

Assemble the remaining Straight Tubes (12), Top Tubes (13), and Foam Sleeves (16) in the same way.

- Insert the end of Straight Pole (12,13) into the hole of POD-connector (4).

Attach the other three Straight Poles (12,13) in the same way. See inset drawing.

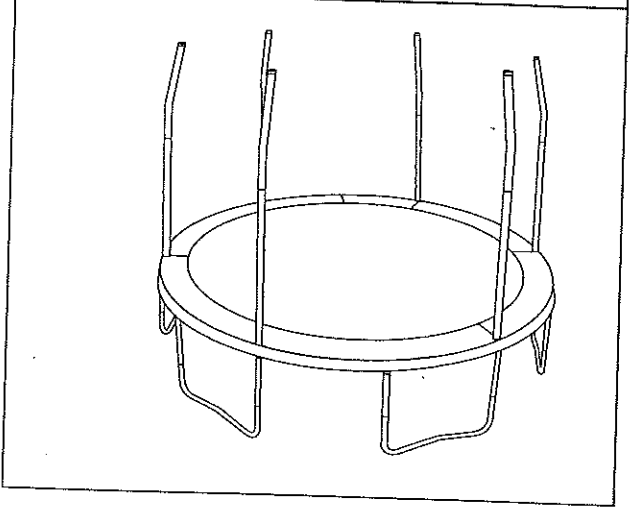
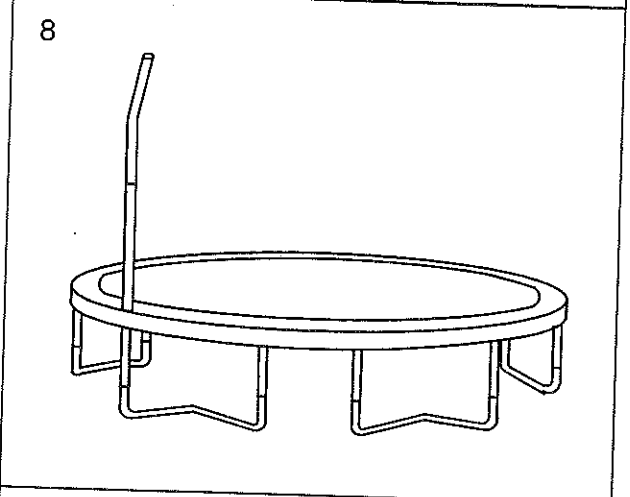
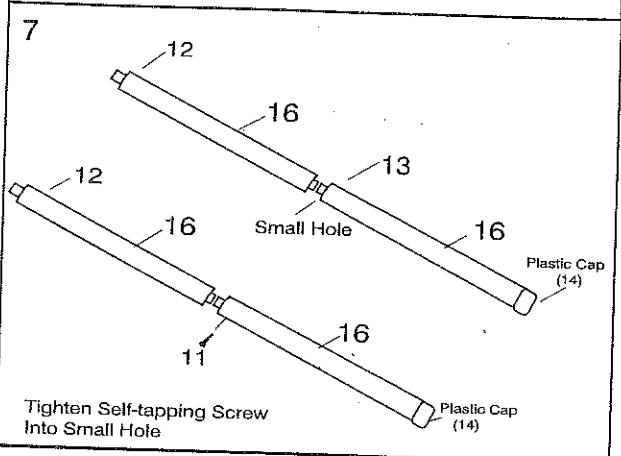
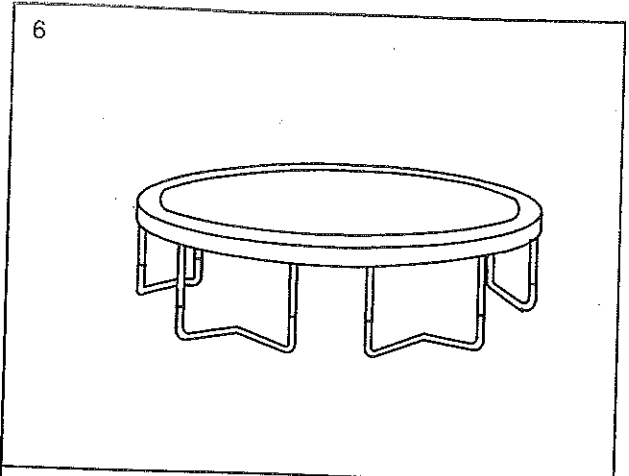
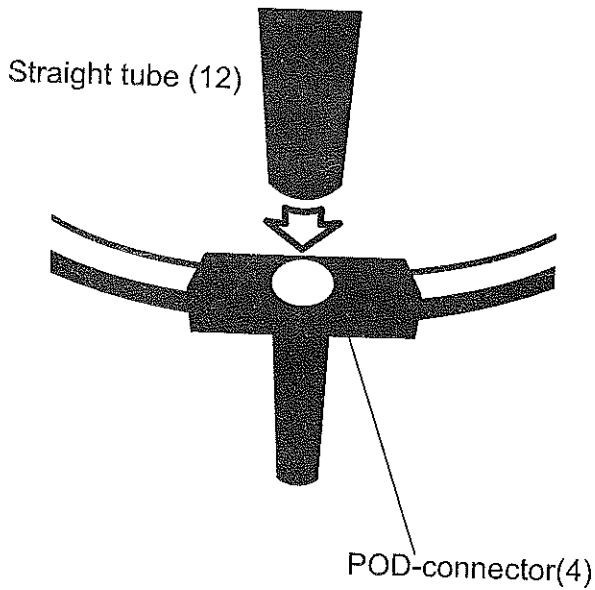

- Lay out Top G3 Pole (17), joint each section Connector to a straight line as shown.

Assemble the remaining Top G3 Pole (17) in the same way.

Spread the Netting (15) on the trampoline bed, insert a Top G3 Pole (17) into the opening of Top Sleeve on the Netting (15). Insert the other Top G3 Pole (17) into the opposite opening of Top Sleeve on the Netting (15).

- Joint each end of Top G3 Pole (17) by the clip of connector at each opening. The Sleeve of the Netting (15) become a round shape.

Attach the first hanging point at the upper edge of the Netting (15) with the G3 Pole (17) to the Plastic Cap (14) of Top Curve pole(13). Attach a second hanging point directly across the Netting (15) from the first hanging point.

Attach the other two hanging point halfway between the first two hanging points, so four hanging points are attached as shown.

- Attach the first hanging point at the upper edge of the Netting (15) with the rod to the Plastic Cap (14) of Top Tube(13). Attach a second hanging point directly across the Netting (15) from the first hanging point.

Attach the other two hanging point halfway between the first two hanging points, so six hanging points are attached as shown.

See inset drawing for attached of Rod:  
Plastic Cap (14) has been attached to the top of the Top Tube(13).

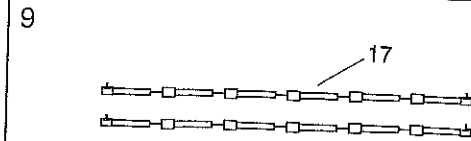
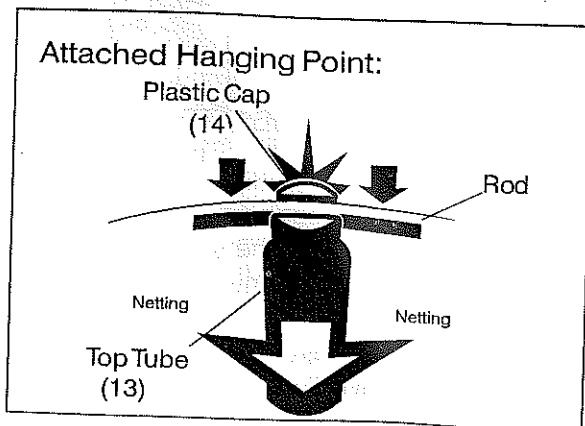

Lay out G3 Pole and Joint each section to one straight line.

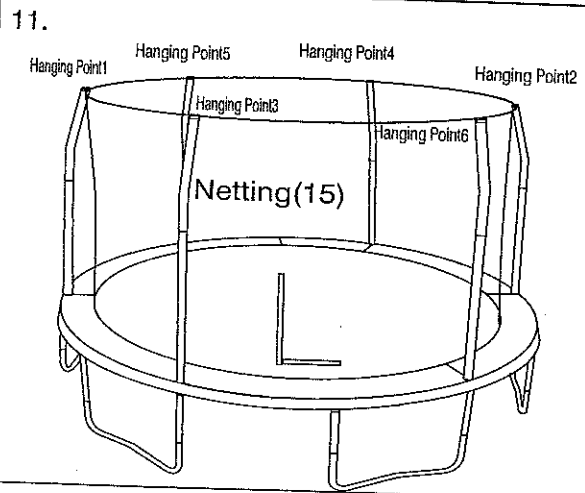
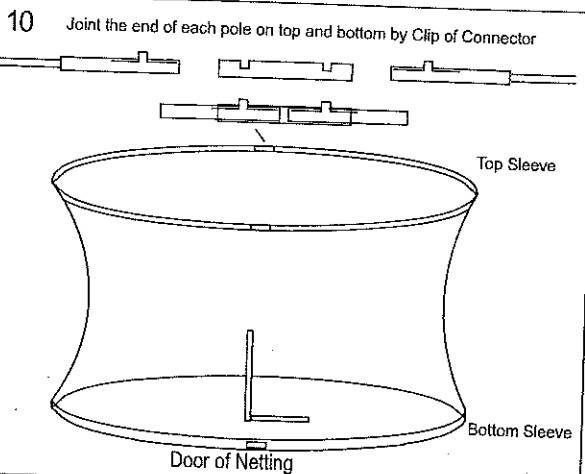
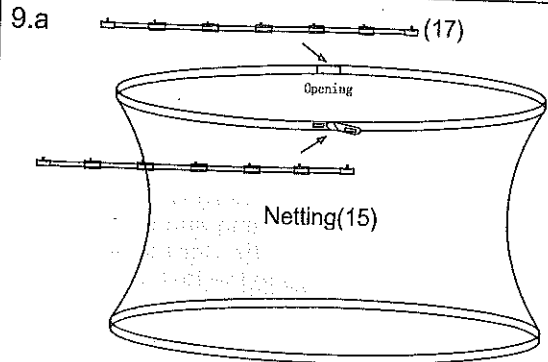

12. Note: During steps 12 and 13, you will "sew" the lower edge of the Netting(15) to the V-rings on the bed using the Cords(19).

Locate the V-ring closest to the door. Thread one end of a Cord(19) through the lower edge of the Netting(15) above the V-ring and then thread the Cord through the V-ring. Tie the Netting to the V-ring, by making a double knot in the Cord.

13. Thread the Cord(19) through the lower edge of the Netting(15) halfway between the first V-ring and the V-ring to the left, and then thread the Cord through the V-ring to the left. Repeat this procedure until the entire Cord is threaded through the Netting and the V-rings as shown. Keep the Cord tight. Tie the end of the Cord to the last V-ring that it reaches.

Tie a second Cord(not shown) to the last V-ring reached by the first Cord. Thread the second Cord through the Netting(15) and the V-ring as described above. Repeat this procedure with the remaining Cords until the last Cord reaches the first Cord. (Note: The last Cord may overlap the first Cord.) Make sure that the Netting is sewn to every V-ring on the trampoline bed; the Netting below the door must also be sewn to the V-rings.

14. Using the included plastic tie, attach the Safety Placard(10) to the Netting(15) near the door as shown.

The trampoline/enclosure is now fully assembled. Make sure that all parts are securely attached. Familiarize yourself and all users of the trampoline/enclosure with the safety precautions, use and instructional materials, and care and maintenance instructions in this manual before using .

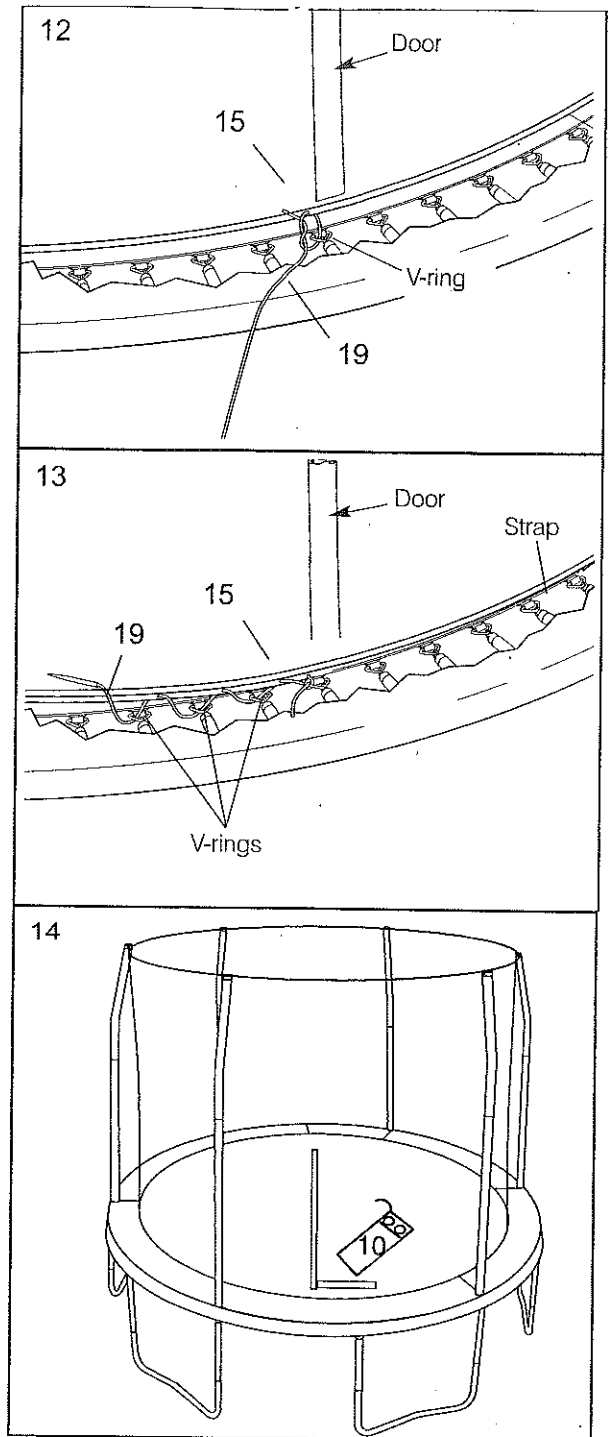

## DISASSEMBLY

To disassemble the trampoline/enclosure, follow assembly steps 1 through 14 in reverse order. Do not attempt to disassemble any trampoline frame components before the springs and the bed have been removed. Use gloves to protect your hands from pinch points during disassembly.

# CARE AND MAINTENANCE

## CARE

Do not allow pets or animals on the trampoline or inside the enclosure, as claws may snag and pull the bed material or damage the frame pad or netting.

The trampoline/enclosure is intended to be used by one person at a time weighing 90 kg (198lbs.) or less. The user should be either barefoot, or wearing gymnastic shoes.

Street shoes or tennis shoes should not be worn on the trampoline. The user should remove all sharp objects from his or her person that may cause injury or damage to the bed. Heavy, sharp, or pointed hard objects should not contact the bed.

Appropriate shoes should be worn inside the enclosure to reduce wear to the bed.

## MAINTENANCE

Your trampoline is manufactured using quality materials and crafted to provide you and your family with many years of enjoyment and exercise. Proper maintenance and care will help to prolong the life of the trampoline and reduce the possibility of injury.

Prolonged exposure to the sun, especially ultraviolet rays, will shorten the life of the enclosure fabric. For longer fabric life, store the enclosure when it is not being used. A dry enclosure, properly stored, will provide the longest life of the fabric, sewing, and hardware. Remove the enclosure from the trampoline during harsh weather conditions or during long periods of non-use.

The following guidelines should always be observed.

Inspect the trampoline/enclosure before each use, and replace any worn, defective, or missing parts. The following conditions could represent potential hazards and increase the danger of personal injury:

- a missing, improperly positioned, or insecurely attached frame pad, netting, enclosure tubes, foam sleeves
- punctures, frays, tears, or holes worn in the bed, frame pad, netting, foam sleeves.
- deterioration in the stitching or fabric of the bed, frame pad, netting
- ruptured or missing springs
- a bent or broken frame, leg, enclosure tubes
- a sagging bed, netting
- sharp protrusions on the frame, suspension system, enclosure tubes

If any of these conditions exists, the trampoline should be disassembled or otherwise protected against use until the condition is remedied.

## REMOVING AND STORING THE TRAMPOLINE/ENCLOSURE

Make sure that the trampoline/enclosure is dry before removing and storing it. Use caution while removing the tubes due to the weight of the tubes.

Once the enclosure is removed from the trampoline, remove all items from the trampoline bed. Make sure that the bed is clean and that it has no tears or holes. Store the trampoline/enclosure in a safe, dry location.

## SPECIAL CONSIDERATIONS

### High Wind

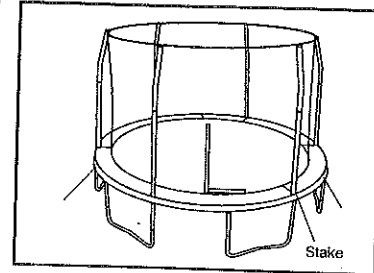

It is possible for the trampoline/enclosure to be blown about by high wind. If you anticipate high winds, the trampoline/enclosure should be moved to a sheltered location, disassembled, or tied down to the ground with ropes and stakes (not included). At least three ropes and three stakes should be used. The tops of the stakes should be at ground level so that they will not create a tripping hazard. In addition, the tops of the stakes should be covered, if necessary, so that users will not be injured by falling onto the stakes. Make sure to attach the ropes to the top of the frame; do not simply secure the legs or the bases to the ground, as they can separate from the frame sockets.

### Moving the Trampoline

If the trampoline/enclosure needs to be moved, it should be moved by two persons, kept horizontal, and lifted slightly. If necessary, the trampoline/enclosure can be disassembled for moving.

To disassemble the trampoline/enclosure, follow the assembly steps in reverse order (see pages 15 to 20). Do not attempt to disassemble the frame sections, legs, or bases before the bed and springs have been removed.

# EXPLODED DRAWING AND PART LIST

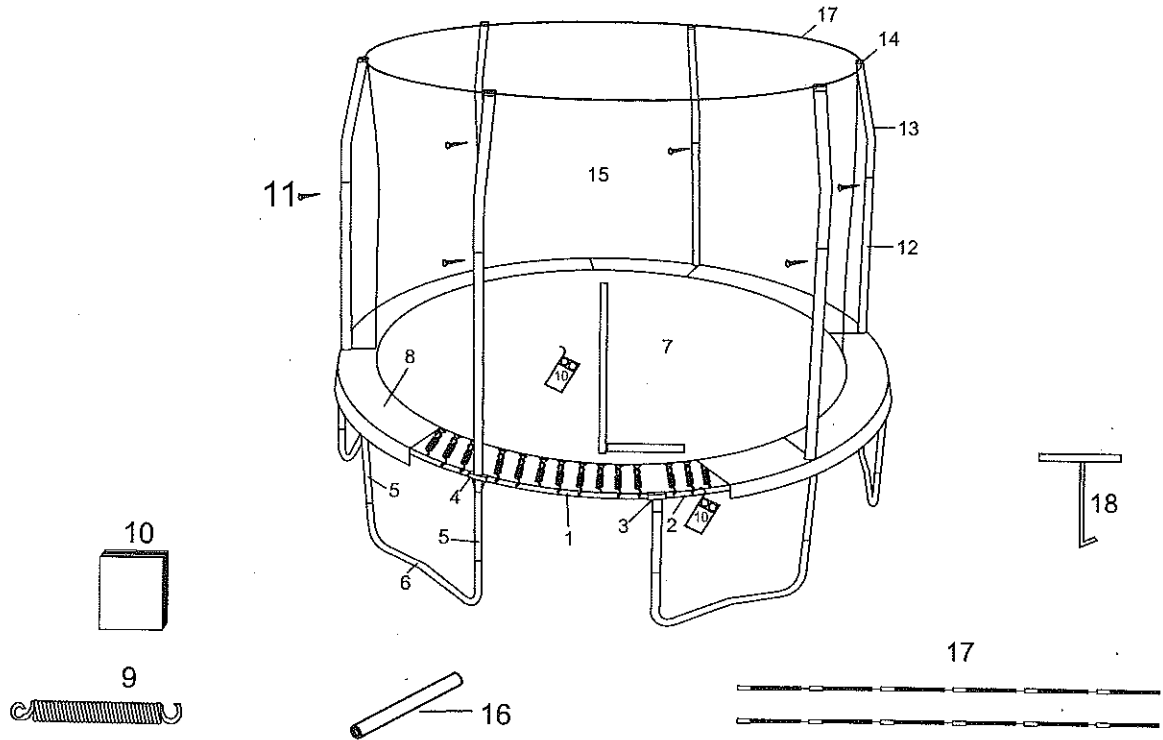

## Trampoline Assembly Parts Listing

## Enclosure Assembly Parts Listing

Key No.	Qty.	Description	Key No.	Qty.	Description
1	6	Top Tube with A/B mark(With T-connector)	12	6	Straight Tube
2	6	Top Tube with A/B mark	13	6	Top Tube
3	6	T-connector with B mark	14	6	Plastic Cap (This part has been attached to the top of the Top tube(13).)
4	6	POD-connector with A mark	15	1	Netting with attached Hardware
5	12	Leg Extension	16	12	Foam Sleeve
6	6	W leg	17	2	FRP
7	1	Stitched Bed with V-ring	18	1	Spring Pulling Tool
8	1	Frame pad	19*	8	Ropes
9	60	Springs			
10	1	Set of User's Manual and placards			
11	6	Self-tapping Screw			

\*This part is not illustrated.  
Specifications are subject to change without notice.







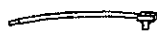

## ORDERING REPLACEMENT PARTS

To order replacement parts, visit our websites at [www.jumpking.com](http://www.jumpking.com) or call our customer hotline (1-877-927-8777). To help us assist you, please provide the following information when calling:

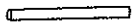
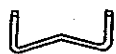



- the MODEL of the trampoline/enclosure
- the KEY NUMBER and DESCRIPTION of the part (see the PART LIST above)
- the quantity needed

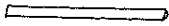
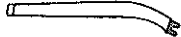
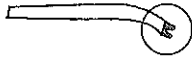
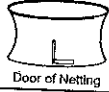

**BS12POD Trampoline Assembly: Parts Listing**

Key No.	Qty	Description	Picture	Part SKU No.
1	6	TOP RAIL FOR T-CONNECTOR WITH A/B MARKING (5 HOLES)		BS12POD-TRT5
2	6	TOP RAIL FOR POD-CONNECTOR WITH A/B MARKING (5 HOLES)		BS12POD-TRP5
3	6	T-CONNECTOR WITH B MARKING		BS12POD-TC
4	6	POD-CONNECTOR WITH A MARKING		BS12POD-PODC
5	12	LEG EXTENSION		BS12POD-LE
6	6	W LEG		BS12POD-WL
7	1	JUMPING SURFACE		BED1260-5.5
8	1	FRAME PAD		PAD12JP6-9G
9	60	5.5" SPRINGS		SP5.5
10	1	USER'S MANUAL AND SAFETY PLACARD		N/A
11	6	SELF-TAPPING SCREW		HWSTS

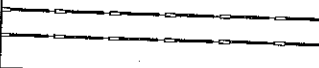
**BS12POD Enclosure Assembly: Parts Listing**

Key No.	Qty	Description	Picture	Part SKU No.
12	6	ENCLOSURE STRAIGHT POLE		BS12POD-ESP
13	6	ENCLOSURE CURVE POLE		BS12POD-ECP
14	6	ENCLOSURE POLE CAP		BS12POD-EPCAP
15	1	12' NETTING WITH G3 FRP POLE FOR 6 POLES	 Door of Netting	NET12-SP6/5.5
16	12	FOAM SLEEVE		FSBLK44
17	1	SET G3 FRP		SETG3-12JP6
18	1	SPRING PULLING TOOL		HWSPT
19	8	PP ROPE		HWROPE-S8

# BounceSAFE™ MC

## 12FT / 3.66M TRAMPOLINE & ENCLOSURE SET

Model: BS12POD

### QUESTIONS?

If you have questions after reading this manual, please call our toll-free Customer Hot Line. The trained technicians on our Customer Hot Line will provide immediate assistance.

Customer Hot Line: 877-927-8777  
Monday-Friday, 8 a.m.-5 p.m. CST.  
[www.jumpking.com](http://www.jumpking.com)

### CONTENTS

IMPORTANT PRECAUTIONS .....	4
WARNING LABEL PLACEMENT .....	6
BEFORE YOU BEGIN .....	6
TRAMPOLINE/ENCLOSURE SAFETY INFORMATION .....	7
USE AND INSTRUCTIONAL MATERIAL .....	11
ASSEMBLY .....	15
CARE AND MAINTENANCE .....	21
EXPLODED DRAWING AND PART LIST .....	22
ORDERING REPLACEMENT PARTS .....	23

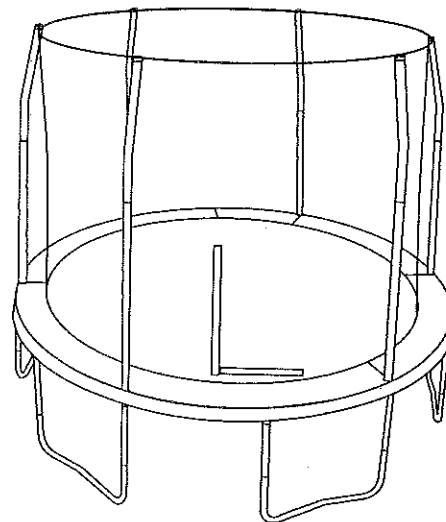

# IMPORTANT PRECAUTIONS

**⚠ WARNING:** To reduce the risk of serious injury, read and follow all warnings, precautions, and instructions in this manual before assembling and using the trampoline.

1. The owner and supervisors of the trampoline are responsible for making sure all the users are aware of practices specified in this manual.
2. Trained Spotter supervision is recommended.
3. Place the trampoline and trampoline enclosure on a level surface before use.
4. Must place the trampoline on lawn, bark wood chip, sand or cushioning materials.
5. Adequate overhead clearance is essential. A minimum of 7.3 m (24 ft) from ground level is recommended. Provide clearance for wires, tree limbs, and other possible hazards.
6. Maintain a free space of minimum 2500mm on all sides of the trampoline. This area should not include concrete, bitumen, brick, or other hard surfaces as these can cause serious injuries.
7. Lateral clearance is essential. Place the trampoline and trampoline enclosure away from walls, structures, fences, and other play areas. Maintain a clear space on all sides of the trampoline and trampoline enclosure.
8. Use the trampoline and trampoline enclosure in a well-lighted area. Artificial illumination may be required for indoor or shady areas.
9. Secure the trampoline and trampoline enclosure against unauthorized and unsupervised use. If an access ladder is used, it should be removed when the trampoline and trampoline enclosure is not in use.
10. Inspect the trampoline and trampoline enclosure before each use, and replace any worn, defective, or missing parts. Make sure the frame padding, barrier, enclosure tubes, and foam sleeves are correctly positioned.
11. Remove any obstructions from beneath the trampoline and trampoline enclosure.
12. The trampoline is designed for users weighing 90kg (198 lbs.) or less. Trampolines over 20 in. (51cm) tall are not recommended for use by children under 6 years of age.
13. Do not allow more than one person on the trampoline and inside the trampoline enclosure. Use by more than one person at the same time can result in serious injuries.
14. Misuse and abuse of the trampoline is dangerous and can cause serious injuries.
15. Use trampoline and trampoline enclosure only with mature and knowledgeable supervision.
16. Climb on and off the trampoline. It is dangerous practice to jump from the trampoline to the floor or ground when dismounting, or to jump onto the trampoline when mounting. Do not use the trampoline as a springboard to other objects.
17. Injury may result from encountering the frame or falling through the springs while getting onto or off the trampoline or while jumping. Stay in the center of the bed when jumping. Do not use the trampoline without the frame pad securely in place to cover the frame. The frame pad is not designed or intended to support the weight of the user. Do not step or jump directly onto the frame pad.
18. The trampoline is a rebounding device that propels the user to unaccustomed heights and into a variety of body movements. Rebounding off the trampoline, striking the frame or springs, or improperly landing on the bed may cause injury.
19. Do not attempt or allow somersaults on the trampoline. This can result in a head injury, broken neck, back, or leg. Landing on the head or neck can cause serious injury, paralysis, or death, even when landing in the middle of the bed.
20. Do not use the trampoline while under the influence of alcohol or drugs. These substances impair reaction time, judgement, and physical coordination.
21. Do not jump on the trampoline while holding an object, particularly one that is sharp or breakable.
22. Bounce only when the surface of the bed is dry. Wind or air movement should be calm to gentle. The trampoline must not be used in gusty or severe winds.
23. The trampoline enclosure is only to be used as an enclosure for a trampoline of a size for which the enclosure is designed.
24. Trampoline equipped enclosure for safety is recommended.

25. Do not attach anything to the barrier that is not a manufacturer approved accessory or part of the enclosure system.
26. Wear clothing free of drawstrings, hooks, loops, or anything that could get caught in the barrier.
27. Enter and exit the trampoline enclosure only at the door designed for that purpose.
28. Do not attempt to crawl under the barrier.
29. Do not attempt to jump over the barrier.
30. Do not intentionally rebound off the barrier.
31. The trampoline frame and the enclosure are made of metal. They are not grounded, and they will conduct electricity. Therefore, an electrocution hazard exists.
32. Keep all frame and heat sources away from the product.
33. Do not hang from, kick, cut or climb on the barrier.
34. Avoid bouncing when tired. Keep turns short.
35. While keeping the head erect, focus eyes on the trampoline toward the perimeter. This will help control bounce.
36. Read all instructions before using the trampoline enclosure and trampoline. Warnings and instructions for the care, maintenance, and use of this trampoline enclosure and trampoline are included to promote safe, enjoyable use of this equipment.
37. To stop bouncing by flexing knees as feet come in contact with the trampoline bed. Learn this skill before attempting others.
38. Learn fundamental bounces and body positives thoroughly before trying more advanced skills. A variety of trampoline activities can be carried out by performing the basic fundamentals in various series and combinations, performing one fundamental after another, with or without feet bounces between them.
39. Avoid bouncing too high. Stay low until bounce control and repeated landing in the center of the trampoline can be accomplished. Control is more important than height.
40. Bounce only when the surface of the bed is dry. Wind or air movement should be calm to gentle. The trampoline must not be used in gusty or severe winds.

## WARNING LABEL PLACEMENT

**Label 1**

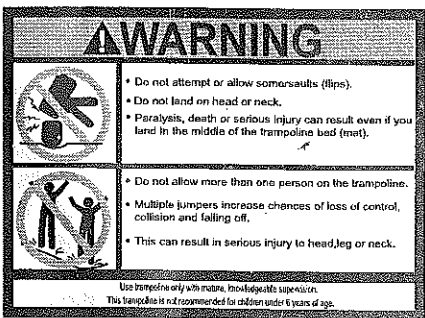

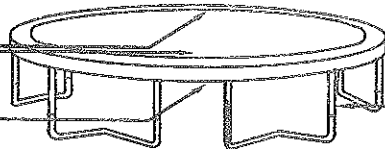

**Label 2**

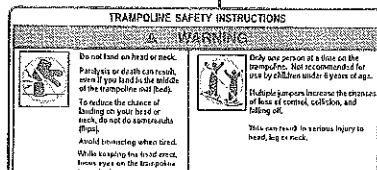

The labels shown on this page have been attached to the trampoline in the indicated locations.

Note: The labels are not shown actual size.

Placard  
(to be attached  
by the owner)

**ATTACH TO TRAMPOLINE**

Made in China

# WARNING PLACARD PLACEMENT

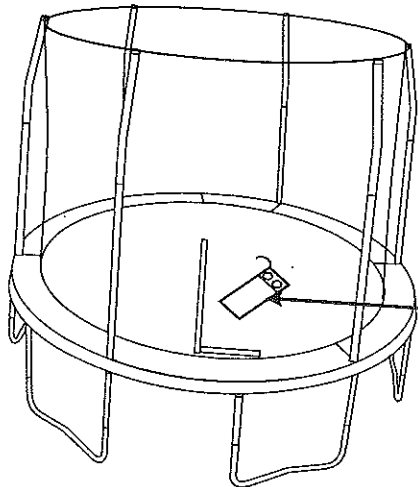

The placard shown at the right must be attached to the trampoline enclosure by the owner.

If the placard is missing or illegible, call our Customer Hot Line toll-free at 877-927-8777, Monday through Friday, 8 a.m. until 5 p.m. Central Time, to order a free replacement placard. Note: The placard is not shown in actual size.



**TRAMPOLINE ENCLOSURE SAFETY INSTRUCTIONS**

**A WARNING**

	<p>Do not land on head or neck.</p> <p>Paralysis or death can result, even if you land in the middle of the trampoline mat (bed).</p> <p>To reduce the chance of landing on your head or neck, do not do somersaults (flips).</p> <p>Avoid bouncing when tired.</p> <p>While keeping the head erect, focus eyes on the trampoline toward the perimeter.</p>		<p>Only one person at a time in the trampoline enclosure.</p> <p>This trampoline enclosure system is not recommended for use by children under 6 years of age.</p> <p>Multiple jumpers increase the chances of loss of control, and this can result in broken head, neck, back, or leg.</p>
---	---	---	---

**For the Supervisor**

- Inspect the trampoline before using. Keep frame pad in place. Do not use when trampoline is wet or in a windy condition. A worn or damaged mat (bed), spring, or frame piece should be replaced immediately.
- Keep objects away that could interfere with the jumper.
- Secure the trampoline against unauthorized and unsupervised use.
- Use trampoline enclosure only with mature, knowledgeable supervision. Enforce all safety rules and be familiar with the information in the User's Manual to help users in following trampoline enclosure instructions and trampoline safety.
- Do not exceed the weight limit recommended by the manufacturer.
- Use only when the enclosure barrier has no holes, pole clamps are tightly secured to the poles, and the support (frame), and the barrier is properly suspended.
- Do not intentionally rebound off the barrier. Do not hang from, kick, cut, or climb on the barrier.
- Wear clothing free of drawstrings, hoods, loops, or anything that could get caught in the barrier.
- Do not attach anything to the barrier that is not a manufacturer approved accessory or part of the enclosure system.

**For the Jumper**

- Do not use the trampoline enclosure system when under the influence of drugs or alcohol.

**Jumping**

- Learn fundamental jumps and body positions thoroughly before trying more advanced skills. Review the User's Manual to learn about how to do basic jumps.
- Stop your bounce by flexing your knees as your feet come in contact with the trampoline mat (bed).
- Avoid jumping too high or for too long. Always control your jump. A controlled jump is one where the take off and land spots are the same.
- Bounce in the center of the trampoline. Focus your eyes on the trampoline mat (bed). Failure to do so may result in a loss of balance and control.
- Do not jump from other objects, building or surfaces onto the trampoline, or into or over the trampoline enclosure.

**Getting on and off**

- Climb on and off the trampoline at the enclosure door or barrier opening. Do not jump on or off. Do not crawl under the barrier. Do not use the trampoline as a springboard to other objects.

For skill training information, contact a trainer certification organization.

**ATTACH TO NETTING AT DOOR**

Made in China

## BEFORE YOU BEGIN

Thank you for selecting a JumpPOD trampoline/ enclosure. "Jumpking / JumpPOD" is designed and crafted to provide many years of fun and fitness. This trampoline/enclosure come equipped with warnings and instructions for the assembly, care, maintenance, and use of the trampoline/enclosure. This information must be read by all trampoline supervisors and users before any person is allowed to jump and use enclosure on the trampoline.

If you have questions after reading this manual, please call our Customer Hot Line at 877-927-8777, Monday - Friday, 8 a.m. until 5 p.m. Central Time (excluding holidays) or visit our website at [www.jumpking.com](http://www.jumpking.com). To help us assist you, please mention the name of the product when calling.

# TRAMPOLINE SAFETY INFORMATION

In trampoline use, as in all active recreational sports, participants can be injured. However, there are steps that can be taken to reduce the risk of injury. In this section, primary accident patterns are identified and the responsibilities of supervisors and jumpers in accident prevention are described.

## ACCIDENT CLASSIFICATION

**Somersaults (flips):** Landing on your head or neck, even in the middle of the trampoline bed, increases the risk of a broken back or neck, which can result in paralysis or death. Such events can occur when a jumper makes an error trying to perform a forward or backward somersault (flip). Do not perform somersaults (flips) on this backyard trampoline.

**Multiple Jumpers:** More than one jumper on the trampoline increases the chance of a jumper becoming injured by losing control of his or her jump. Jumpers may collide with one another, fall off the trampoline, fall on or through the springs, or land incorrectly on the bed. The lightest weight jumper is the jumper most likely to be injured.

**Mounting and Dismounting:** The trampoline bed is several feet from ground level. Jumping off the trampoline to the ground or any other surface may result in injury. Jumping onto the trampoline from a roof, deck, or other object also represents a risk of injury. Smaller children may need assistance getting onto or down from the trampoline. Climb carefully onto and off the trampoline. Do not step onto the springs or the frame pad. Do not grasp the frame pad to pull yourself onto the trampoline.

**Striking the Frame or the Springs:** Injury may result from encountering the frame or falling through the springs while jumping or getting onto or off the trampoline. Stay in the center of the bed when jumping. Make sure to keep the frame pad in place to cover the frame. The frame pad is not designed nor intended to support the weight of the trampoline user. Do not step or jump directly onto the frame pad.

**Loss of Control:** Jumpers who lose control of their jump may land on the bed incorrectly, land on the frame or springs, or fall off the trampoline. A controlled jump is one where the landing is in the same spot as the takeoff. Before learning a more difficult maneuver, the preceding one should be performed consistently under control. Attempting a maneuver beyond present skill levels increases the chance of loss of control. To regain control and stop your jump, bend your knees sharply when you land.

**Alcohol or Drug Use:** The chance of injury increases when a jumper has consumed alcohol or taken drugs. These substances impair a person's reaction time, judgment, and physical coordination.

**Encountering Objects:** Use of a trampoline while other people, pets, or objects are underneath it will increase the chance of injury. Jumping while holding or having an object on the trampoline, particularly one that is sharp or breakable, will increase the chance of injury. Placing a trampoline too close to overhead electrical wires, tree limbs, or other obstructions can increase the chance of injury.

**Poor Maintenance of the Trampoline:** Jumpers may be injured if a trampoline is used when it is in poor condition. A torn bed, bent frame, broken spring, or missing frame pad, for example, should be replaced before anyone is allowed to jump. Inspect the trampoline before each use.

**Weather Conditions :** A wet trampoline bed is too slippery for safe jumping. Gusty or high winds can cause jumpers to lose control. To reduce the chance of injury, use the trampoline only under appropriate weather conditions.

**Access:** To prevent access to the trampoline by unsupervised smaller children, the access ladder should always be removed and stored in a secure location when the trampoline is not in use.

## METHODS OF ACCIDENT PREVENTION

### The Supervisor's Role in Preventing Accidents

It is the responsibility of the supervisors of trampoline users to provide knowledgeable and mature supervision. They need to know and enforce all the rules and warnings set forth in this manual to minimize the likelihood of accidents and injuries and to inform users of these rules. During periods of time when supervision is unavailable or inadequate, this may require that the trampoline be disassembled, placed in a secure area, or otherwise secured against unauthorized use. Another option that may be considered is covering the trampoline with a heavy tarp that can be secured with locks and chains.

### The Jumper's Role in Preventing Accidents

Education on the part of the user is a must for safety. Users must first learn a low, controlled bounce and then learn the basic landing positions and combinations before proceeding to intermediate skills. Jumpers must understand why they have to master "control" before they can start thinking about other moves. Understanding the proper progression of skills in jumping on a trampoline must be the first lesson. Review this manual to learn about the basic techniques for using the trampoline. For further information or additional instructional materials, contact a certified trampoline instructor.

## TRAMPOLINE SAFETY INSTRUCTIONS

### For the Supervisor

Read the instructions before using the trampoline. Enforce all of the safety rules and be familiar with the information in this manual to help new users learn basic jumps and all users follow trampoline safety. All trampoline users must have mature, knowledgeable supervision, regardless of the skill or age of the jumper.

This trampoline is not recommended for use by children under 6 years of age.

Inspect the trampoline before using it. Do not use the trampoline without the frame pad securely in place to cover the frame. Do not use the trampoline when it is wet or in a windy condition. A worn or damaged bed, spring, or frame piece should be replaced immediately.

Keep objects away that could interfere with the jumper.

Secure the trampoline against unauthorized and unsupervised use.

### For the Jumper

Do not use the trampoline when under the influence of drugs or alcohol.

Avoid bouncing when tired.

## JUMPING

Learn fundamental jumps and body positions thoroughly before trying more advanced skills. Be alert to your own limitations in the execution of trampoline skills. Review this manual to learn how to do basic jumps.

Stop your bounce by flexing your knees as your feet come in contact with the trampoline bed. Learn this skill before attempting others.

Avoid jumping too high or for too long. Always control your jump. A controlled jump is one where the takeoff and landing spots are the same.

Bounce in the center of the trampoline. Focus your eyes on the frame pad. Failure to do so may result in a loss of balance and control.

Take turns jumping, one at a time, and always have someone watch you.

## GETTING ON AND OFF

Climb onto and off the trampoline; do not jump onto it or off it. Do not use the trampoline as a springboard to other objects. For additional information regarding skill training, contact a trainer certification organization.



# TRAMPOLINE ENCLOSURE SAFETY INFORMATION

## NEED FOR TRAMPOLINE ENCLOSURE SAFETY

A trampoline enclosure is a recreational product.

The information on this page and on page 10 identifies important safety precautions. The precautions are not all-inclusive, because an enclosure can be used in ways that this manual cannot cover completely.

To prevent pinches and cuts during enclosure use, a frame pad must be installed on the trampoline. (See the trampoline manufacturer's instructions.) The frame pad must be installed before the enclosure is erected. The frame pad reduces the chance of injury from accidental contact with the springs and frame.

## USING THE ENCLOSURE SAFELY

### Adult Supervision of Children

Children using a trampoline with a trampoline enclosure must be supervised by adults. Young children must be supervised constantly. Adults must pay particular attention to:

- things that children bring into the enclosure.
- children's activities inside the enclosure.
- conditions inside the enclosure while children are using it.
- the way children get into and out of the enclosure.

Additional details of safe enclosure use are described below.

### Electrocution Hazard Associated with the Metal Frame of the Trampoline and Enclosure

The trampoline and enclosure frames are made of metal. They are not grounded, and they will conduct

electricity. Lights, electric heaters, extension cords, and household electrical appliances are not permitted in or on the trampoline or enclosure.

### Hazards Associated with Entering and Exiting the Trampoline Enclosure

A trampoline enclosure installed on a trampoline is raised off the ground. The height of the enclosure increases the risk of a fall when a jumper is entering or exiting the enclosure. Young children in particular may have difficulty getting into and out of the enclosure. To reduce the risk of falling, help young children to get into and out of the enclosure.

Enter and exit the trampoline enclosure only through the door of the enclosure (the opening in the netting walls). The trampoline bed and the netting walls of the enclosure are separate pieces; jumpers, particularly young children, must not exit the enclosure by going out between the bed and the netting walls. Trying to exit in this way poses a risk of strangulation from being caught between the trampoline frame and the netting walls.

Darkness increases the chances of a fall when a jumper is entering or exiting the enclosure. Do not use the trampoline unless adequate lighting is provided.

### Hazards Associated with Animals and Sharp and Breakable Objects

To avoid damage to the trampoline enclosure and the trampoline, do not allow pets or other animals inside of the enclosure. The claws and teeth of animals can damage the netting. Do not jump on the trampoline while holding or wearing a sharp or breakable object.

### Hazards Associated with High Winds

A trampoline with an enclosure can be moved or blown over by high winds, potentially injuring anyone in its path or anyone inside of the enclosure. If you anticipate high winds, take down the enclosure netting, and stake the trampoline frame to the ground (see page 22), or move the trampoline and enclosure to a sheltered location.

### Storing the Trampoline Enclosure Safely

Specific steps for storing the trampoline enclosure are presented later in this manual. There are specific safety precautions to be aware of when storing the enclosure.

Remove the attached tube sections as a unit, and separate them on the ground. Avoid pinching your fingers by keeping your fingers away from pinch points near the bracket assembly while you are removing the tubes from the frame.

### Placing the Trampoline in a Safe Place

There must be at least 7.3 m (24 ft.) of clear, open space above the trampoline bed. Do not place or store anything underneath the trampoline.

To avoid injury, the trampoline must be kept away from objects and possible hazards including electric power wiring, tree limbs, and fences. Do not place the trampoline near any other recreational devices or structures such as a swimming pool or swing set.

The trampoline must be placed on a level surface before use, and the area around the trampoline must always be well lighted.

### For the Supervisor

Be familiar with the information in this manual and enforce all of the safety rules. Help new users and all users to use the trampoline and enclosure safely.

All trampoline users must have someone watch them, regardless of the skill or age of the user.

Secure the trampoline against unauthorized and unsupervised use. Keep the trampoline free of objects that could interfere with the jumper.

This trampoline enclosure is not recommended for use by children under 6 years of age or by anyone weighing more than 90 kg (198 lbs.).

Use the trampoline only when the bed is clean and dry. Inspect the trampoline and enclosure prior to each use and replace any worn or damaged parts. Use only when the enclosure netting has no holes, the clamps are tightly secured to the tubes and the frame, and the netting is properly suspended.

### For the Jumper

Do not use the trampoline enclosure when under the influence of drugs or alcohol.

Avoid jumping too high or for too long. Always control your jump.

Take turns jumping one at a time, and always have someone watch you.

Do not attempt to jump over the netting. Do not intentionally rebound off the netting. Do not hang from, kick, cut, or climb on the netting.

Wear clothing that is free of drawstrings, hooks, loops or anything that could get caught in the netting.

Do not attach anything to the netting that is not a approved accessory or part of the trampoline enclosure.

### How to Enter and Exit the Trampoline Enclosure

Enter and exit the trampoline enclosure only through the door in the netting. To enter the enclosure, first unfasten the plastic clips on the door and unzip the zippers. Place one knee on the frame pad and climb head first through the door. Refasten the plastic clips and close the zippers.

To exit the enclosure, first unzip the zippers on the door and unfasten the plastic clips. Sit on the bed of the trampoline and climb feet first through the door. When you are through the door and sitting on the frame pad, step or jump safely to the ground. Close the zippers and refasten the plastic clips.

# USE AND INSTRUCTIONAL MATERIAL

## OVERVIEW OF TRAMPOLINE USE

The first periods of trampoline use should focus on learning fundamental body positions and practicing the eight basic bounces that are described on pages 13 and 14 in this manual.

During this learning period, jumpers should practise these basic techniques and perfect them. Braking, or checking the bounce, should be taught first and stressed as a safety measure. Jumpers should brake their jump whenever they start to lose balance or control. This is done by simply flexing the knees sharply upon landing and absorbing the upward thrust of the bed. This enables the jumper to stop suddenly and avoid losing control.

In trampoline use, the takeoff point and landing point of a good, controlled jump are in the same spot. An exercise is considered learned only when a jumper is able to perform it consistently. Jumpers should never proceed to any advanced step until they can perform all previous techniques consistently.

Allow each jumper a brief turn on the trampoline. Extended bouncing exposes an overtired user to an increased risk of injury. Longer turns tend to lessen the interest of others waiting to jump. Clothing should consist of a T-shirt and shorts. Jumpers should wear regulation gymnastic shoes or heavy socks, or they may jump barefoot. Street shoes or tennis shoes

should not be worn on the trampoline. Beginning jumpers may wish to wear loose-fitting protective clothes, such as a long-sleeve shirt and pants, until correct landings are mastered. This will reduce the chance of mat (bed) burns from improper landings on elbows and knees. No hard-sole shoes should be worn, as they cause excessive wear on the trampoline bed.

Mounting and dismounting properly should be a strict rule from the beginning. Users should climb onto the trampoline by placing their hands on the frame and stepping or rolling up onto the frame, across the springs, and onto the bed. Do not step directly onto the frame pad or grasp the frame pad when mounting or dismounting the trampoline. Users should always place their hands on the frame while mounting or dismounting. To dismount, jumpers should walk to the side of the bed, bend over and place one hand on the frame, and then step from the bed to the ground. If you have installed the optional ladder, its rungs can be used to mount or dismount. Always face the ladder and place your hands on the frame. Make sure your foot has secure contact with the ladder rung when using it.

Reckless bouncing should not be permitted. All skills should be learned at moderate heights. Control, rather than height, should be emphasized. Jumpers should be forbidden to practice alone and unsupervised.

A tramp  
blown  
in its  
ar

examples of an instructional  
w a complete discussion  
mechanics between the  
) . See pages 13 and 14  
trampoline skills.

leg is brought forward from the standing (not  
bouncing) position, and the drop to the back with  
the chin held forward to the chest and the eyes f  
ward on the frame pad. Spotting this skill is most  
important. Demonstration of back drop with low  
bounce and practice of both techniques.

- 1. Mounting and dismounting—Demonstration and practice of proper techniques.
- 2. Fundamental bounce—Demonstration and practice.
- 3. Braking (checking the bounce)—Demonstration and practice. Braking on command.
- 4. Hand and knee drop—Demonstration and practice, stressing four-point landing and alignment.

Lesson 2

- 1. Review and practice of skills previously learned.
- 2. Knee drop—Half twist to the right, to the left, to the feet, and then to the knees.
- 3. Seat drop—Half twist to the feet. Seat drop, knee drop, hand and knee drop, repeat.

Lesson 3

- 1. Review and practice of skills previously learned.
- 2. Front drop—To save time and avoid mat (bed) burns, all students should be requested to assume the front drop position on the floor while the instructor checks for faults. Suggested progression: from hand and knee bounce, the body is extended for the landing in the front drop position, and the rebound is made to the feet.

- 3. Practice routine—Hand and knee drop, front drop, feet, seat drop, half twist to feet.

Lesson 4

- 1. Review and practice of skills previously learned.
- 2. Back drop—Demonstration, emphasizing the forward thrust of the hips by arching the body as one

Lesson 5

- 1. Review and practice of skills previously learned, encouraging original routines based on them.
- 2. Half turntable—Start from the front drop position and push to the left or right with the hands. Turn the head and shoulders in the same direction. Keep the back parallel to the bed and the head up. After completing a half turn, land in the front drop position.

Lesson 6

- 1. Swivel hips—Suggested progression: seat drop, feet, half twist, repeat; seat drop, half twist to feet, repeat; seat drop, half twist to seat drop.
- 2. Half turntable.

Lesson 7

The student should now be encouraged to design and organize routines, with emphasis on good form. The instructor may judge or grade students and arrange groupings for further instruction accordingly.

To stimulate interest in competition, the game of "Trampoline Horse" can be introduced. Before the game begins, students must count off. To start the game, student number 1 performs a stunt. Student number 2 then mounts the trampoline and performs the same stunt and adds a second stunt. Student number 3 mounts and performs stunts 1 and 2 and adds a third stunt. Thus, the series of stunts is continuously lengthened. The first person to miss a stunt in the series assumes the letter "H" and starts a new series with a stunt. If a person misses again, he assumes the letter "O." The first person to accumulate "H-O-R-S-E" is eliminated from the game. The last remaining contestant is the winner.

Lesson planning from this point should be facilitated by contacting a certified trampoline instructor.

# BASIC TRAMPOLINE SKILLS

## Fundamental Bounce

1. Start from a standing position with your head erect and your eyes on the frame pad.
2. Swing your arms forward and up in a circular motion.
3. Bring your feet together and point your toes downward while in the air.
4. Keep your feet about 30 cm (15 in.) apart when landing on the bed.

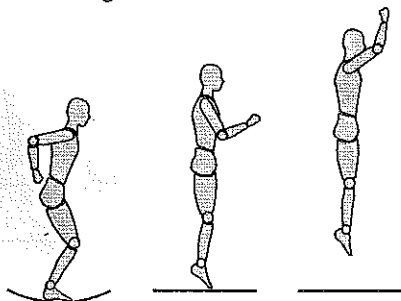

## Knee Drop

1. Start bouncing from a standing position, keeping your eyes on the frame pad.
2. Land on your knees, keeping your back straight and your body erect.
3. Come back up to an erect position.

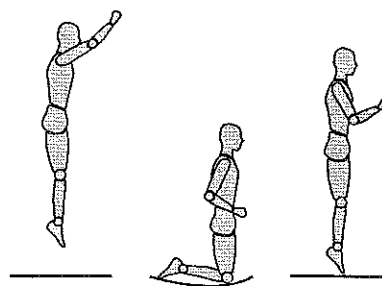

## Hand and Knee Drop

1. Start bouncing from a standing position, keeping your eyes on the frame pad.
2. Land on the bed on your hands and knees.
3. Push with your hands and come back up to an erect position.

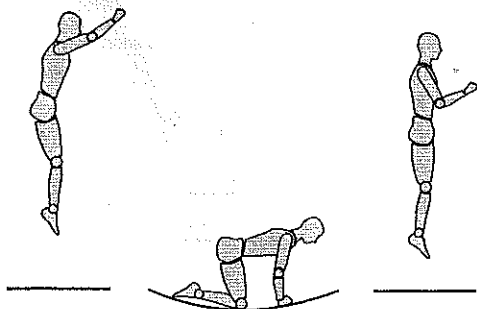

## Back Drop

1. Start from a low bounce and land on your back.
2. Keep your chin forward on your chest as you land.
3. Kick forward and up with your legs to return to an erect position.

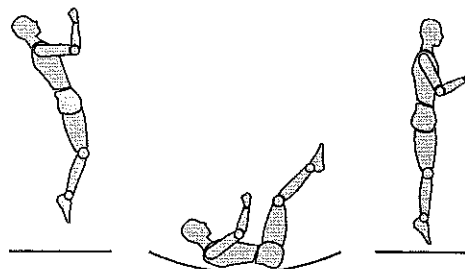

### Seat Drop

1. Land in a sitting position with your legs parallel to the bed.
2. Place your hands on the bed beside your hips.
3. Push with your hands to return to an erect position.

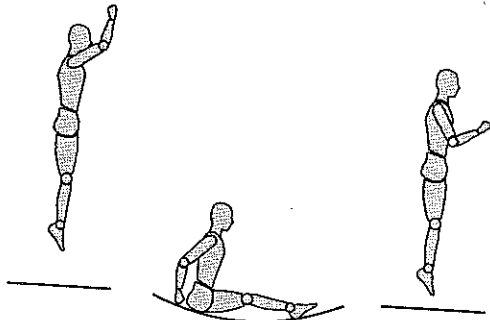

### Front Drop

1. Start from a low bounce and land on the bed in a prone position.
2. Keep your head up and your arms extended forward on the bed.
3. Push with your arms to return to an erect position.

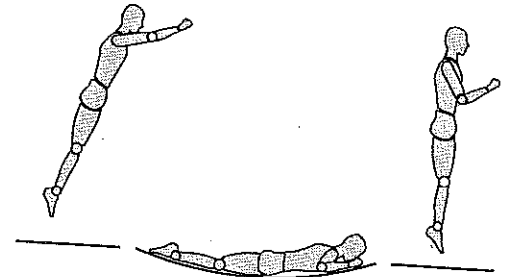

### Half Turntable

1. Start from the front drop position and push to the left or right with your arms to begin turning your body in the opposite direction.
2. Turn your head and shoulders toward the direction that your body is turning.
3. Keep your back parallel to the bed and your head up.
4. After completing a half turn, land in the front drop position.

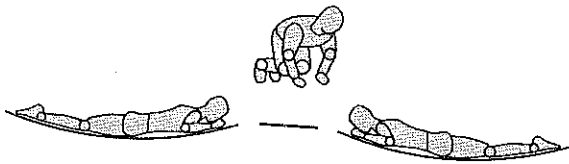

### Swivel Hips

1. Start with a seat drop.
2. Turn your head to the left or right and swing your arms up in the same direction.
3. Turn your hips in the same direction as your head and arms, completing a twist.
4. Land in the seat drop position.

